

### OEM Applications

AEG, Active, AL-KO, Alpina, Black+Decker, Bosch, Castor, Cub Cadet®, Dolmar, Draper, Echo®, Efco®, Einhell®, Gardena, Greenworks, Grizzly, Hecht, Hitachi, Homelite®, Husqvarna®, Ikra, Iseki, Jonsered®, Makita®, McCulloch®, MTD, Oleo-Mac®, Partner, Poulan®/Poulan Pro®, Ryobi®, Shindaiwa, Skil®, Solo, Stiga, Tanaka®, Zenoah e altri.

• Carlton® : 10

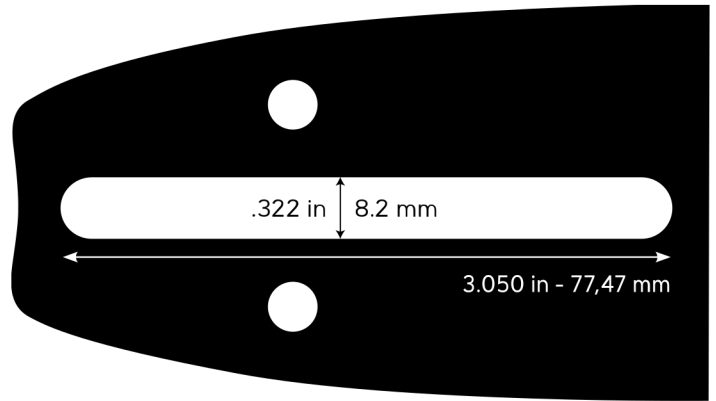

## A074

### OEM Applications

Alpina, Castor, Metabo®, Oleo-Mac®, Stiga®, Stihl®

• Carlton® : 26

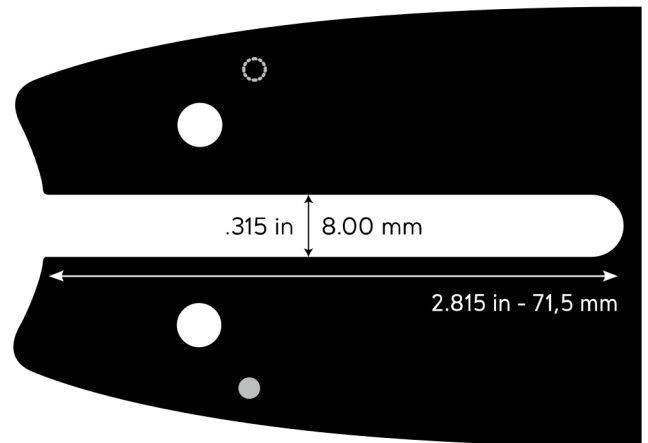

## A095

### OEM Applications

AL-KO, Alpina, Castor, Cub Cadet®, Dolmar, Efco®, Einhell®, Hecht, Homelite®, Husqvarna®, Jonsered®, Makita®, McCulloch®, Metabo®, Mitox, MTD, Oleo-Mac®, Partner, Pioneer, Poulan®/Poulan Pro®, Ryobi®, Shindaiwa, Solo®, Stiga®, Zenoah® e altri.

• Carlton® : 01

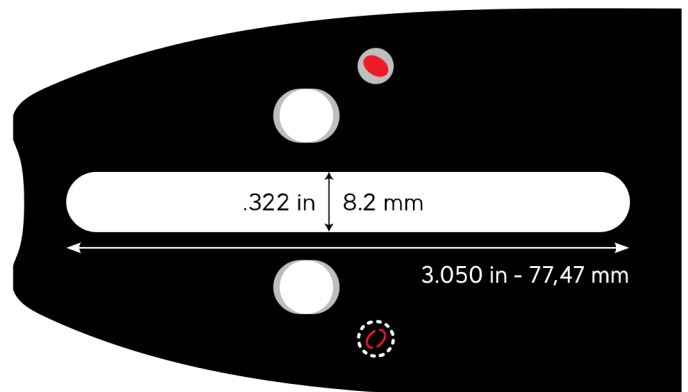

## A108

---

**OEM Applications**  
Campagnola.

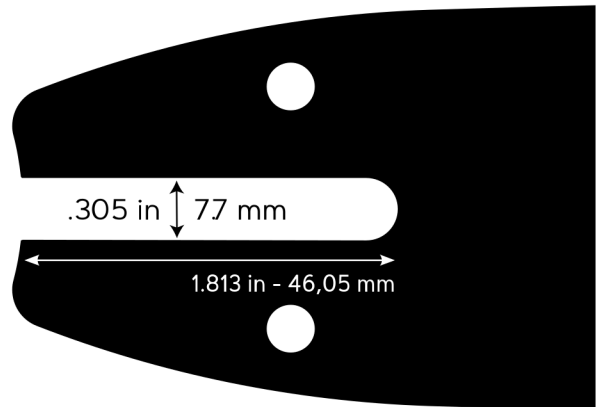

## A129

---

**OEM Applications**  
Efco®, Grizzly, Oleo-Mac®

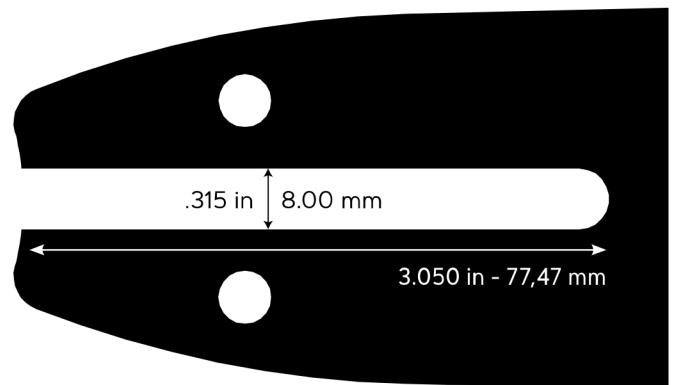

## A218

---

**OEM Applications**  
Active, AL-KO, Black+Decker®, Bosch, Dolmar, Makita®, McCulloch®, Power Pruner®/Echo® Power Pruner®, Polesaws, Ryobi®, Shindaiwa, Stiga® e altri.

• Carlton® : 29

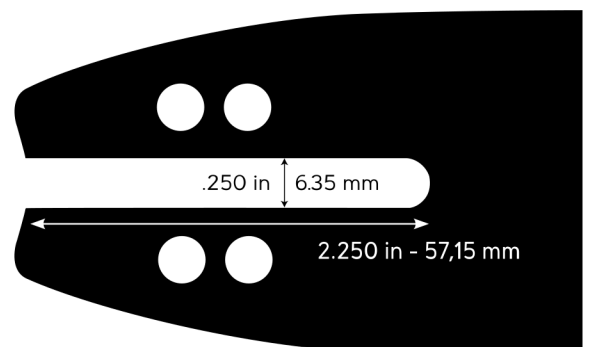

## A318

### OEM Applications

AL-KO, Black+Decker®, Dolmar, Echo®, Efco®, Einhell®, Grizzly, McCulloch®, Oleo-Mac®, Ryobi®, Shindaiwa, Stiga® e altri.

• Carlton® : 38

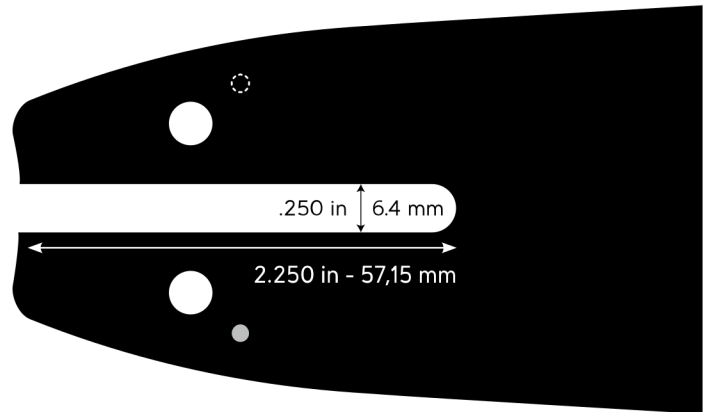

## K041

### OEM Applications

AEG, Active, AL-KO, Alpina, Black+Decker, Bosch, Castor, Cub Cadet®, Dolmar, Draper, Echo®, Efco®, Einhell®, Gardena, Greenworks, Grizzly, Hecht, Hitachi, Homelite®, Husqvarna®, Ikra, Iseki, Jonsered®, Makita®, McCulloch®, MTD, Oleo-Mac®, Partner, Poulan®/Poulan Pro®, Ryobi®, Shindaiwa, Skil®, Solo, Stiga, Tanaka®, Zenoah e altri.

• Carlton® : 10W

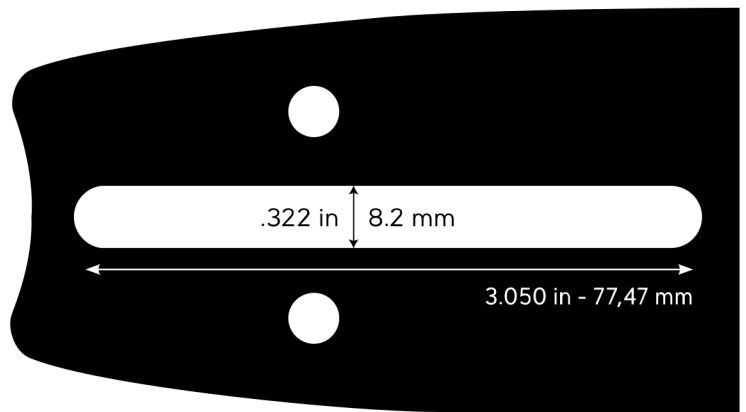

## K095\*

### OEM Applications

AL-KO, Alpina, Castor, Cub Cadet®, Dolmar, Efco®, Einhell®, Hecht, Homelite®, Husqvarna®, Jonsered®, Makita®, McCulloch®, Metabo®, Mitox, MTD, Oleo-Mac®, Partner, Pioneer, Poulan®/Poulan Pro®, Ryobi®, Shindaiwa, Solo®, Stiga®, Zenoah® e altri.

• Carlton® : 01W

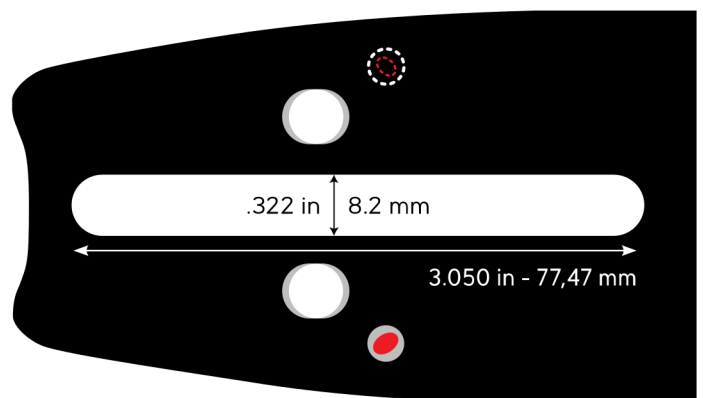

**\*Note:** In un numero ristretto di casi, qualora due barre abbiano la stessa lunghezza nei rispettivi numeri di parte, ma un diverso numero di maglie motrici, nella descrizione dell'attacco della barra sarà utilizzata la lettera Z, in modo da distinguerle (ad esempio, K095 e Z095).

## B083

---

### OEM Applications

Dolmar, Makita®.

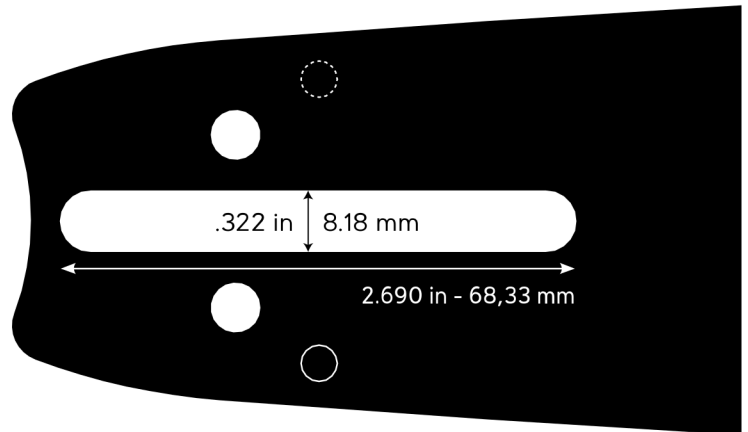

## K153

---

### OEM Applications

Dolmar, Makita®.

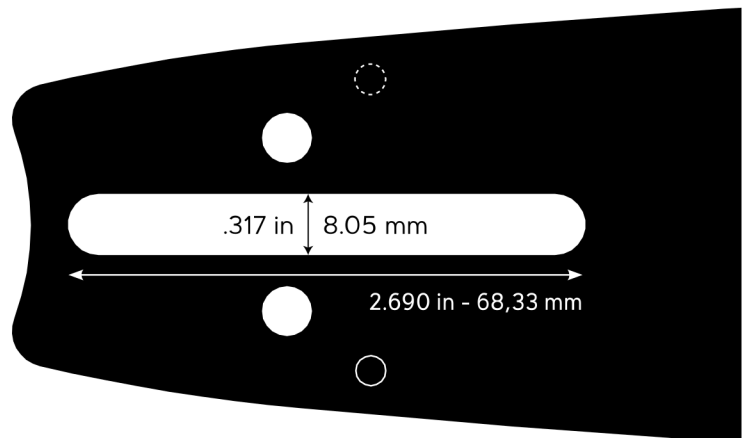

## K216

---

### OEM Applications

Echo®, Shindaiwa.

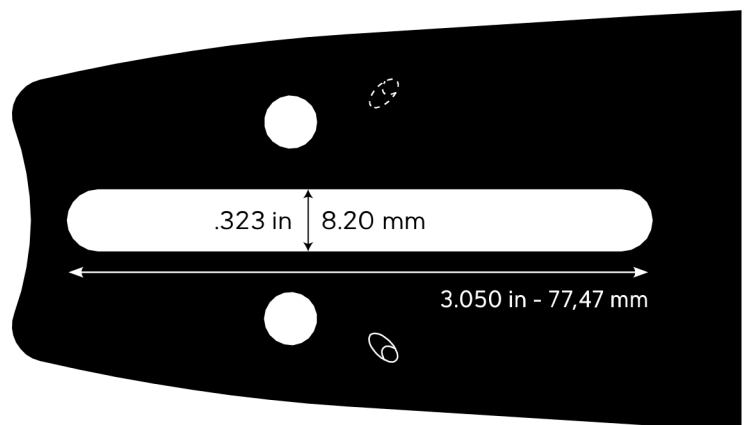

## D009

---

### OEM Applications

Alpina, AL-KO, Dolmar, Efco®, Husqvarna®, Iseki, Jonsered®, Makita®, Oleo-Mac®, Partner, Shindaiwa, Solo®.

• Carlton® : 81

\*Note: VXL ha fori ovali e scanalature più corte

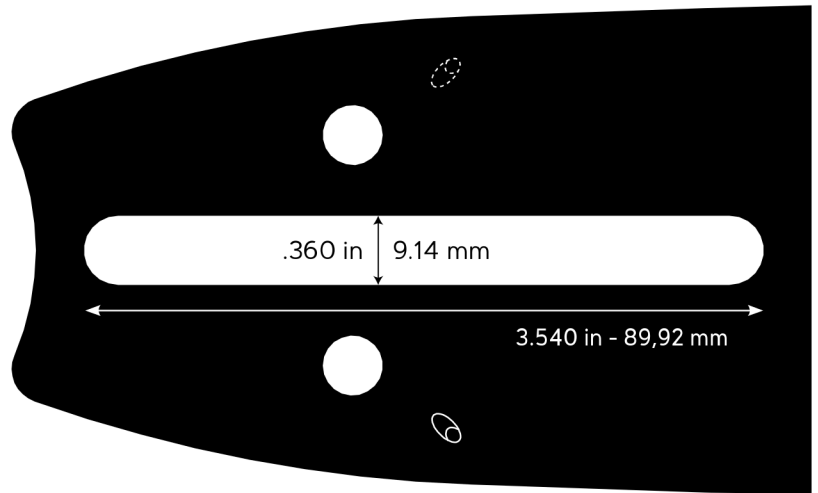

## D024

---

### OEM Applications

Efco®, Ikra, Jonsered®, Oleo-Mac®, Partner.

• Carlton® : 71

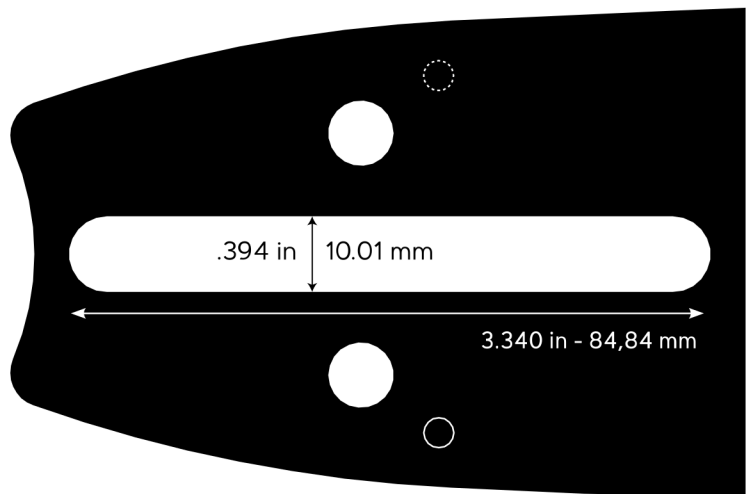

## D025

---

### OEM Applications

AEG, Stihl®

• Carlton® : 42

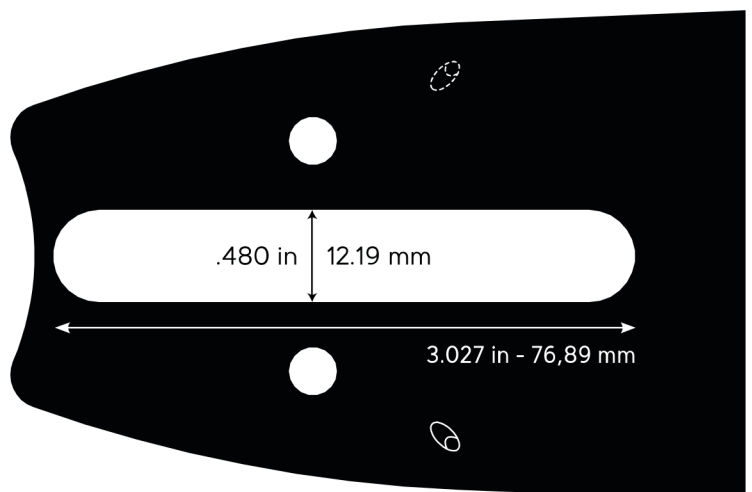

## D033

---

### OEM Applications

Dolmar, Makita®, Poulan®

• Carlton® : 55

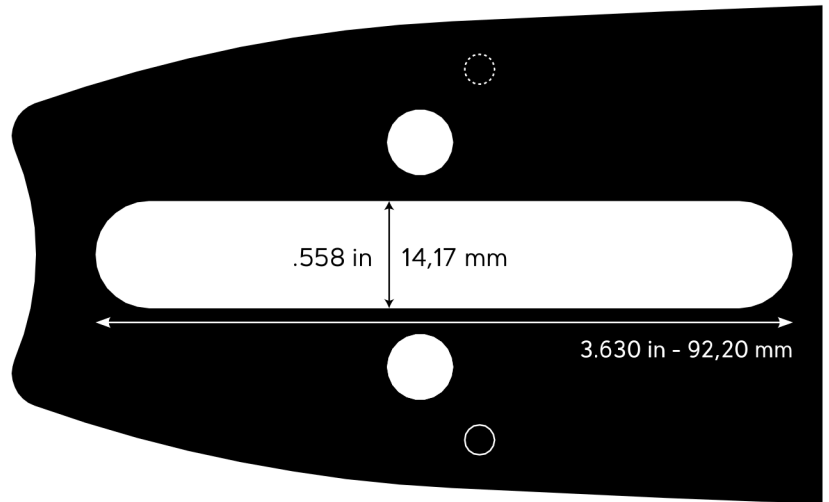

## D176

---

### OEM Applications

AL-KO, Echo®, Poulan®/Poulan Pro®,  
Shindaiwa, Tanaka®, Zenoah®.

• Carlton® : 41

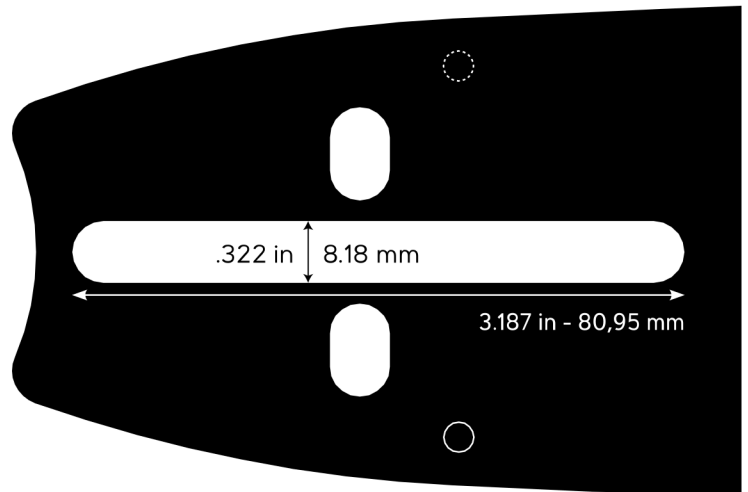

## E031

---

### OEM Applications

Efco®, Hydrochief, Oleo-Mac®, Stihl®

• Carlton® : 55

